



OWNER'S MANUAL

TOMY®

CAUTION - ELECTRICALLY OPERATED PRODUCT

NOT RECOMMENDED FOR CHILDREN UNDER 8 YEARS OF AGE. AS WITH ALL ELECTRIC PRODUCTS, PRECAUTIONS SHOULD BE OBSERVED DURING HANDLING AND USE TO PREVENT ELECTRIC SHOCK.

PARENTS PLEASE NOTE : IT IS RECOMMENDED THAT THIS TOY BE PERIODICALLY EXAMINED FOR ANY POTENTIAL HAZARDS AND SHOULD NOT BE USED UNTIL APPROPRIATE REPAIRS ARE MADE.

**POWER PACK RATING : INPUT : 120 VAC, 60HZ, 0.12A
OUTPUT : 22 VDC 7VA**

1. CAUTION: UNPLUG POWER PACK BEFORE CLEANING TRACK

- Always clean the track before you start racing. Use an eraser to clean the Track Rails, then wipe away residue with a clean dry cloth.
- Blow out any deposits that may have fallen in the track grooves.
- You may also use the special track pad provided or a coin to clean the Track Rails. Simply lay a coin flat on the Rails and polish until shiny.
- NEVER use steel wool to clean the Track.

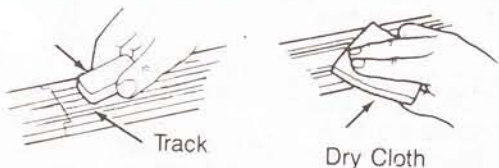

2. Choose a layout from the Layout Sheet.

- ### 3.
- Assemble the straight or curved Track on a flat, clean surface. Do not assemble Track on carpeting.
 - Push the pieces of Track together until they lock in place.
 - Assemble pieces of Track to form the layout of your choice.

4. Pull the pieces apart to disassemble.

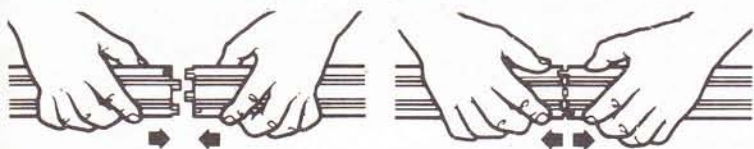

- ### 5.
- Attach a Guardrail to each curve section by placing the Guardrail Tabs under the Track, then snapping up into place.

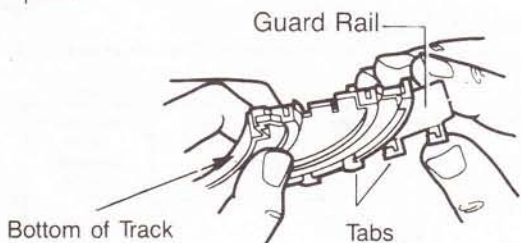

- ### 6.
- Snap the Trestles together as shown.
 - Attach the Trestles to Track as needed.

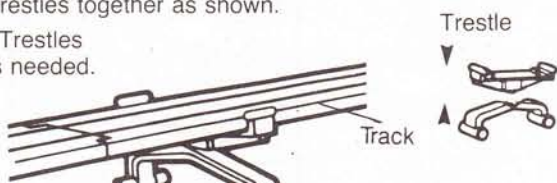

- ### 7.
- Slide the Accelerators' Plugs into the Terminal Track.
 - Slide the Power Pack 2-Way Racing Plug into the Terminal Track as shown.
 - Plug the Power Pack into an electrical wall outlet (110-120 Volts, AC).

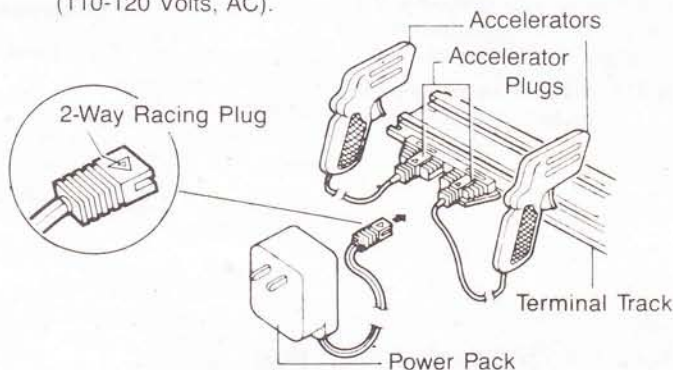

- ### 8.
- Place cars on Track. Make sure Guide Pin fits into Slot on Track.

NOTE: Operate only one car per lane.



- ### 9.
- Squeeze the Trigger on the Accelerator to make the car accelerate. The more you squeeze the Trigger, the faster the car runs!
 - To reduce speed, simply decrease pressure on the Trigger.
 - Releasing the Trigger stops the car.



Here are a few maintenance items you may need which are not included in this set:

- Eraser • Dry Cloth • Cellophane Tape • Coin • Toothpick • Small Screwdriver

NOTE: THE 2-WAY RACING PLUG ALLOWS YOU TO CHANGE DIRECTION OF TRAVEL! FLIP THE PLUG OVER TO REVERSE RACING DIRECTION.

- On sets using Lapometers, insert the plug with the arrow pointing in the same direction as the arrows on the Lapometer.

REMEMBER: Always disconnect Power Pack when not in use. Never pull on wires. Always remove connections by pulling the Plug.

Cleaning/General Maintenance

TRACK

Use an Eraser to clean all Track Rails. Wipe away residue with a clean dry cloth. You can also lay the special Track Pad provided or a coin flat on the Rails and rub until Rails are shiny. Blow into the grooves to remove any small particles. Periodically wipe tracks with a clean cloth to remove excess dust.

A. CLEAN TIRES & TRACK

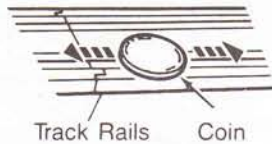

TIRES

Place a strip of cellophane tape on a table as shown. Roll rear tires across the tape a few times.

B. ADJUST WHEELS

If the wheels bind against the car's chassis, use a screwdriver to carefully pry the wheels out.

NOTE: Make sure wheels do not extend past or rub body.

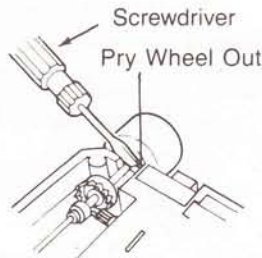

C. POOR TRACK CONNECTION

Check to make sure all Track sections are properly connected.



D. CLEAN LINT FROM AXLES

Use a toothpick to remove excess lint, dirt, and dust from around the axles.

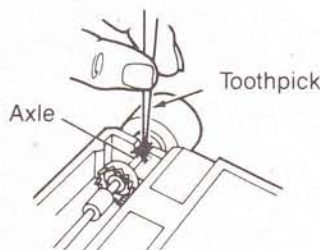

E. CLEAN OR REPLACE PICK UP SHOES

Regularly clean Pick-Up Shoes by carefully rubbing them with a clean pencil eraser or special Track pad provided.

Do not apply too much pressure or you may bend the Pick-Up Shoes. Do not use steel wool to clean shoes.

If Pick-Up Shoes are slightly or unevenly worn, switch them around.

After excessive wear, you should replace Pick-Up Shoes. See section "Performing a Tune-Up" on how to replace worn-out Pick-Up Shoes.

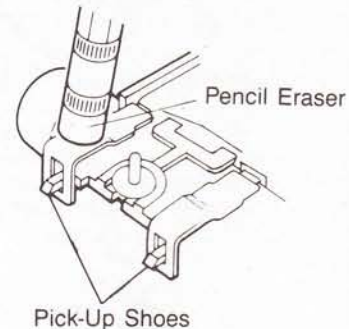

F. REALIGN CHASSIS

Occasionally, the car's snap-on body may shift, causing the tire to rub against the body. Hold the car upside-down and center the chassis until it snaps back into position.

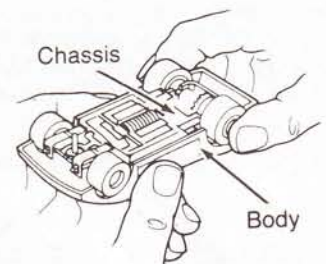

TROUBLESHOOTING CHART

Refer to the Troubleshooting Chart below for your particular problem.

	A.	B.	C.
PROBLEM	Dirty Track & Tires	Wheels Rub Chassis	Poor Track Connection
Cars Won't Run	.	.	.
Cars Hesitate	.	.	.
Cars Squeak/Run Noisy	.	.	.
Cars Run Slowly/Overheat	.	.	.

Performing a Tune-Up

To keep your car running in top performance, here's the mechanics guide to AFX tune-ups. A pair of spare shoes and springs are included. Ask your Toy or Hobby Dealer for the AFX Tune-Up Kit (No. 8634) which includes all the parts you need for a complete tune-up.

NOTE: Before you begin, place a piece of white paper under your work area to make pieces easier to find.

1. REMOVING BODY

A. Hold Rear Wheels. Pull out on one side of Body until it clears the Chassis Tab, then remove Body.

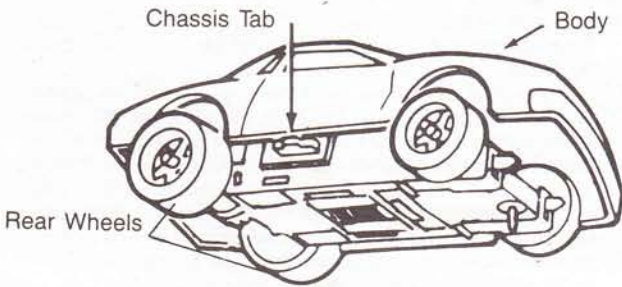

2. REPLACING PICK-UP SHOES

A. Carefully pull Pick-Up Shoe forward.
B. Lift up Shoe and remove.
C. Replace with new Shoes.

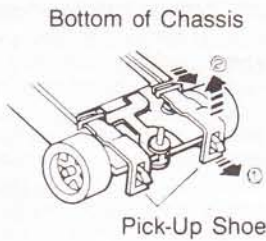

3. REPLACING SHOE SPRINGS

A. After removing Pick-Up Shoes (see "REPLACING PICK-UP SHOES" above), replace Springs as shown.

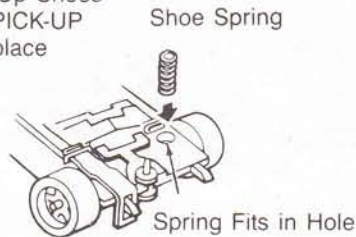

4. REPLACING REAR AXLE ASSEMBLY

A. In the AFX Tune-Up Kit, the Rear Axle comes assembled with Gear Spacer and Crown Gear already in place. Simply snap Rear Wheel Assembly in as shown, then slide Tires onto Wheels.

NOTE: You may need to adjust the Wheels: see "Troubleshooting" Section B.

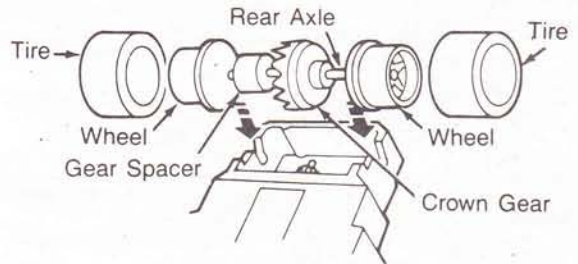

5. REPLACING PINION GEAR

NOTE: Rear Axle must first be removed before replacing Pinion Gear. See section above "REPLACING REAR AXLE ASSEMBLY" for instructions.

A. Insert small screwdriver blade as shown and push Pinion Gear rearward to remove.
B. Slide new Pinion Gear onto Motor. Push into place.

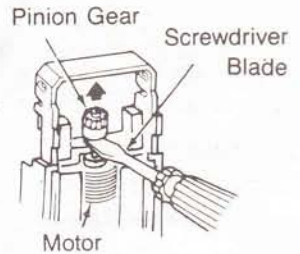

6. REPLACING GUIDE PIN

A. Simply push Guide Pin out of Slot and replace with a new Guide Pin (available in AURORA Tune-Up Kit No. 8634).
B. Guide Pin slides and snaps into place.

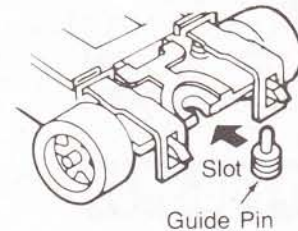

7. REPLACING BODY

A. Slide one end of Chassis Tab into Body, then snap other side into place.

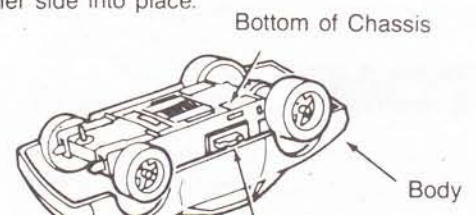

TROUBLESHOOTING

When you have a problem, then look for Diagrams A through F for the best solution.

D.	E.	F.
Dirty Cars	Dirty Worn Pick-Up Shoes	Wheel & Body Interference
	.	.
.	.	
		.
.	.	.
		.

AFX® Super G-Plus™ Chassis Exploded View— Parts Identification

Fig. A

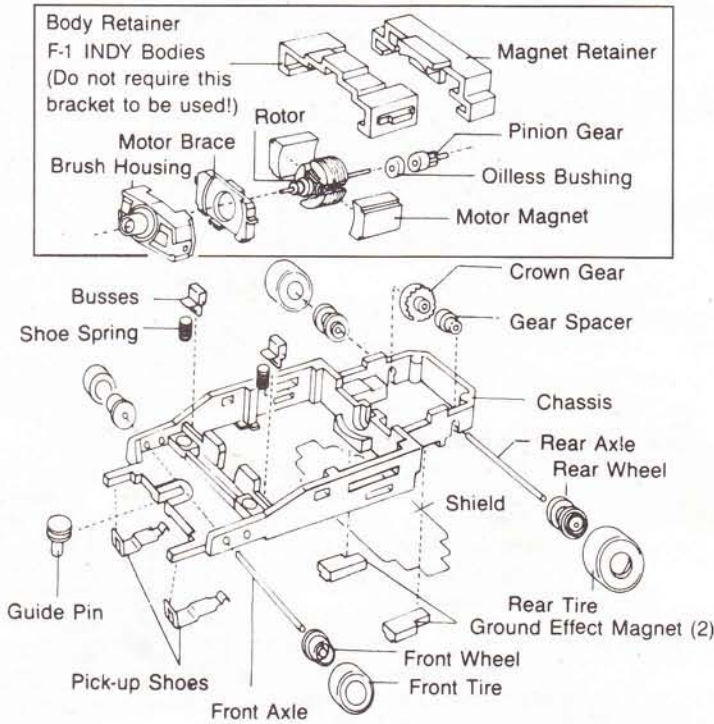

NOTE: Magnets have a white marking on one side. White marking is to be facing up away from the bottom of the chassis.

Fig. B

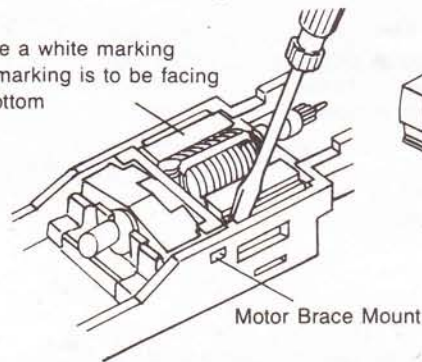
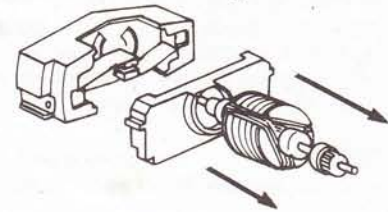

Fig. C



REMOVING/REPLACING MOTOR

- First remove the magnet retainer from the rear of the chassis. Then remove rear axle assembly and shield. See exposed view for detail and position of parts.
- Using a small screwdriver, place the head between the magnet and chassis as shown on Figure B. Note that the placement of the screwdriver should be close to the motor brace mount. Once placed move the screwdriver inward toward the magnet and move up. The motor should now be raised a little. At this point push up from underneath the chassis. You should now be able to remove the motor. To reassemble just reverse process.
- When detaching the motor from the brush housing, be careful as to not damage the brush (see Figure C.)

NOTE: Magnets have a white marking on one side. White marking is to be facing up away from the bottom of the chassis.

RECTIFICATION TIMING ADJUSTMENT OF MOTOR (Fig. D)

Your Super G-Plus Car comes with a timing adjustment function that allows you to adjust the car for different racing tracks. Adjust to the left to increase the RPM's of the motor. This function is used for long racing tracks with few curves. Adjust to the right to increase the torque of the motor. This function is used for racing tracks with a lot of curves and few straights.

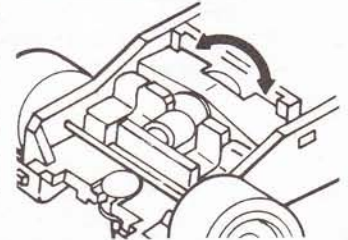

NOTE TO PARENTS: Periodically examine this racing set, power pack, cars and track for potential hazards. Look for loose connections or frayed wiring. Any hazardous parts should be immediately repaired or replaced before use.

FOR SERVICE, ADDITIONAL
PARTS AND A COMPLETE
CATALOG OF HIGH
PERFORMANCE PARTS,
CALL TOLL FREE-

(877) 866-9239

RACEMASTERS

TOMY CORPORATION

Distributed by: Racemasters, Inc.

P O Box 68021 Anaheim Hills, California 92817

Printed on recycled paper

IMPORTANT

CLEAN TRACK BEFORE USE

DUE TO THE ATMOSPHERE A THIN FILM MAY BUILD UP ON THE TRACK SURFACE.

THEREFORE, FOR OPTIMUM PERFORMANCE IT IS NECESSARY TO CLEAN THE TRACK BEFORE USE - SEE INSTRUCTIONS.

- Printed on recycled paper.